



2026 - Edition 1

PRODUCT CATALOGUE



CONTENTS

Agricultural Fencing	
Stakes, Rails & Poles	2
Wire Products	4
Concrete Products	6
DuraPost	7
Fencing Materials	
Self Build Fencing Materials	8
Fence Panels	10
Trellis	13
Wood Decking & Cladding	
Decking Components	14
Cladding	15
Ellumiere Lighting Systems	16
Weed & Ground Control	17
Sleepers & Treated Timber	
Sleepers, Tree Stakes & Pegs	18
Pressure Treated Timber	19
Gates & Posts	
Garden Gates	20
Driveway Gates	22
Field, Galvanised Gates & Posts	25
Fixtures & Fittings	
Gate Fittings	26
Decorative Fencing Accessories	27
Sheds & Summerhouses	
Sheds	28
Summerhouses	30
Protek Paint Ranges	32
Outdoor Animal Housing	34
Garden, Bin & Log Stores	35
Garden Furniture	
Arches, Arbours & Pergolas	36
Picnic Tables & Bench Seats	37
Other	
Sheet Materials	38
Hotline Electric Fencing	39
Conversion Chart	41

ABOUT US



Scan for our
Showroom
3D Virtual Tour



Scan for our
Workshop
3D Virtual Tour



Bespoke Handmade Timber Products with more than 40 Years of experience.

Yarcombe Woodland Products has been established for over 40 years serving the local community. We specialise in the supply of UK grown Fencing Stakes and Tanalised Timber which enables us to maintain a high quality and durable product.

We manufacture on site to allow us to provide a bespoke service for your Driveway, Garden and Field Gates, Fencing Panels, Sheds and much much more. We pride ourselves on the quality of our service and products. We also offer an extensive range of Wire, Galvanised Gates, Electric Fencing and a large variety of Fixtures and Fittings to cover all your timber needs.

Call: +44 1460 76238
Email: info@yarcombewp.com
Web: www.yarcombewp.com

 Follow us
[yarcombewp](https://www.instagram.com/yarcombewp)

 Find us
[yarcombewoodland](https://www.facebook.com/yarcombewoodland)

A delivery service is available at a nominal charge, roadside/driveway drop only.

Prices are correct at the time of publication but are subject to alteration without prior notice. All prices quoted in this brochure inclusive of VAT at 20%.

TANALISED PEELED STAKES

SPECIFICATION	COST
1.35m x 50 - 100mm dia.	£4.16
1.65m x 50 - 75mm dia.	£4.40
1.65m x 75 - 100mm dia.	£5.92
1.65m Half Round	£4.59
1.83m x 75m - 100mm dia.	£6.62
2.40m x 50 - 75mm dia.	£6.35
2.40m x 75 - 100mm dia.	£10.02

From
£4.16

Suitable for a wide range of applications, all our peeled fencing stakes are treated on site using Tanalith E preservative and are pointed at one end. All sizes are approximate and the stakes will vary in size along the length.



TANALISED PEELED STRAINERS

SPECIFICATION	COST
1.83m x 100 - 125mm dia.	£10.65
2.10m x 125 - 150mm dia.	£18.89
2.40m x 125 - 150mm dia.	£22.62
2.40m x 150 - 175mm dia.	£29.53
2.40m x 175 - 200mm dia.	£39.06
2.70m x 100 - 125mm dia.	£18.21
3.00m x 150 - 175mm dia.	£36.52

Used as the main strengthening component in agricultural fencing, all our peeled fencing strainers are pointed at one end and are treated on site using Tanalith E preservative. All sizes are approximate and the stakes will vary in size along the length.



TANALISED MACHINED STAKES

SPECIFICATION	COST
1.20m x 50mm dia.	£3.47
1.50m x 50mm dia.	£4.14
1.80m x 50mm dia.	£4.96
2.40m x 60mm dia.	£7.01
1.80m x 75mm dia.	£5.66
1.80m x 100mm dia.	£9.82
1.80m Half Round	£5.59

From
£3.47

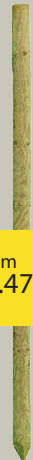

BOND TIMBER STAKES & STRAINERS

SPECIFICATION	COST
1.65m x 75mm - 100mm dia.	£8.57
1.80m x 75 - 100mm dia.	£8.99
2.10m x 125-150mm dia.	£26.21
2.40m x 75 - 100mm dia.	£13.36
2.40m x 150 - 175mm dia.	£40.32

Pointed Cundy Peeled Stakes & Strainers with 30 year service life WPA Approved Gold Treatment.

Exclusively selected quality redwood, dried to the correct moisture content before using the gold treatment which offers a 30 year service life. The gold standard treatment is set at double the strength of standard UC4 – (essential for ground contact) with the timber in the treatment tank for 5 hours rather than 1.5 hours. This means that the treatment penetrates further into the timber providing better protection from the elements and ultimately extending the desired service life for the strainer.

TANALISED MACHINED HALF ROUND RAILS

SPECIFICATION	COST
3.66m x 75mm Face.	£7.31
3.66m x 88mm Face.	£7.78
3.66m x 100mm Face.	£9.94

CREOSOTE STAKES, STRAINERS & RAILS

SPECIFICATION	COST
1.65m x 75 - 100mm dia.	£8.93
1.80m x 75 - 100mm dia.	£9.74
2.40m x 75 - 100mm dia.	£13.08
2.10m x 125 - 150mm dia.	£28.31
2.40m x 150 - 175mm dia.	£44.03
2.40m x 175 - 200mm dia.	£60.32
3.60m 87mm x 38mm Rail	£10.51
2.1m 125mm x 75mm Pointed Post	£17.24
3.60m x 100m HR Rail	£13.30

As a durable alternative to our Tanalised fencing components, all our creosoted stakes & strainers are kiln dried redwood to ensure a consistent treatment and long lifespan. All are cundey peeled and sizes and diameters are approximate.



PEELED CHESTNUT STAKES & STRAINERS

SPECIFICATION	COST
Cleft 1.83m x 75 - 100mm	£6.69
Full Round 1.83m x 75 - 100mm	£7.83
Full Round Strut 2.40m x 75 - 100mm	£12.79
Full Round Strainer 2.10m x 125mm min	£22.75
Full Round Strainer 2.40m x 150mm min	£31.00
Full Round Strainer 2.40m x 200mm min	£33.14

British sweet chestnut provides an environmentally friendly and long lasting fencing material. Rustic in appearance it is a natural product from sustainable sources. Chestnut does not rely on chemicals or other treatments to provide a long lasting and aesthetically pleasing product. The diameter will vary along the length on the both the stake and strainer.

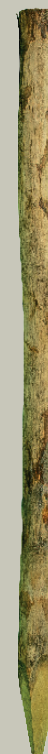

PRESSURE TREATED POST & RAIL

SPECIFICATION	COST
3.66m x 87mm x 38mm	£8.64
4.80m x 87mm x 38mm	£11.33
1.80m x 125mm x 75mm	£13.67
2.10m x 125mm x 75mm	£15.96

From
£8.64



Ideal for fields or large gardens, our softwood Post & Rail fencing components are pressure treated using Tanalith E Preservative. A traditional farm fencing choice.

CHESTNUT POST & RAIL

SPECIFICATION	COST
2.00m Sawn Morticed Post 2 Rail	£29.65
2.00m Sawn Morticed Post 3 Rail	£31.56
2.90m Long Cleft and Ended Chestnut Rail	£17.34

From
£28.24

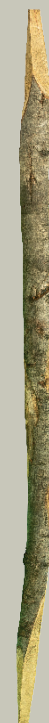

Traditional cleft chestnut Post & Rail, is ideal for a rustic garden fencing alternative or stock control. A long lasting hardwood with a unique finish.

TANALISED MACHINED POLES

SPECIFICATION	COST
3.60m x 75mm dia.	£14.09
3.60m x 100mm dia.	£21.13

TANALISED PEELED HALF ROUND RAILS

SPECIFICATION	COST
3.66m x 100 - 125mm dia.	£9.98



GALVANISED WIRE NETTING

SPECIFICATION	10M	25M	50M
600mm x 13mm x 22g	£22.02	£44.10	£101.40
600mm x 25mm x 20g	£19.02	£48.90	£84.00
600mm x 50mm x 19g	£11.94	£26.10	£50.40
900mm x 13mm x 22g	£30.60	£75.00	£151.80
900mm x 25mm x 20g	£29.10	£73.50	£105.60
900mm x 50mm x 19g	£19.20	£40.32	£60.30
1050mm x 31mm x 19g Rabbit	-	-	£81.60
1200mm x 13mm x 22g	£43.62	£91.02	£171.00
1200mm x 25mm x 20g	£39.30	£90.00	£137.40
1200mm x 31mm x 19g Rabbit	-	-	£93.60
1200mm x 50mm x 19g	£26.76	£52.20	£85.20
1800mm x 25mm x 19g	-	£157.20	£218.40



From
£11.94

Made with flexible steel, this netting is an ideal material to use for poultry runs and enclosures, crop guards, rabbit proofing and for general purpose fencing. Manufactured from galvanised wire, the netting is hot dip galvanised once again to ensure double corrosion resistance.

TORNADO STOCK FENCE

SPECIFICATION	LENGTH	COST
HT5/53/15 High Tensile Hedge Bottom	100M	£117.34
HT5/53/30 High Tensile Hedge Bottom	100M	£97.40
R6/85/22 H.T. Grippled Pheasant Friendly	100M	£144.58
R8/80/15 High Tensile	100M	£164.92
R8/80/30 High Tensile	100M	£136.21
R8/80/22 High Tensile	100M	£145.36
C8/80/15 Mild Steel	50M	£68.84
C8/80/30 Mild Steel	50M	£60.56
R13/192/15 Deer Fence	100M	£328.34
RL13/192/15 Deer Fence	100M	£249.54



From
£60.56

ESTATE WIRE STOCK FENCE

SPECIFICATION	LENGTH	COST
FX6/80/22 Pheasant	100M	£115.02
FX8/80/15	100M	£152.04
FX8/80/22	100M	£126.00
FX8/80/30	100M	£120.10
FX8/97/22	100M	£141.74
FX8/97/22	250M	£372.00
FX13/120/7.5	50M	£231.00
FX13/190/15	100M	£302.40

EstateWIRE FX combines 2Life® anti-corrosive technology with the rigid, strength forming advantages of the FX knot to deliver a stronger, longer lasting agricultural fence.

NOTE: The FX13/190/15 100m is NOT a stock item and is ordered when needed.

500m Rolls of FX8 can also be ordered in.



From
£120.10



CHAIN LINK

SPECIFICATION	LENGTH	COST
900mm x 50mm x 2.50mm Galv. Chain Link	12.5m	£82.20
900mm x 50mm x 2.50mm Galv. Chain Link	25m	£156.00
1200mm x 50mm x 2.50mm Galv. Chain Link	12.5m	£103.20
900mm x 50mm x 2.50/1.70mm Green Chain Link	12.5m	£58.80
900mm x 50mm x 2.50/1.70mm Green Chain Link	25m	£117.60
900mm x 50mm x 3.15/2.24mm Green Chain Link	25m	£144.00
1200mm x 50mm x 2.50/1.70mm Green Chain Link	12.5m	£75.60
1200mm x 50mm x 2.50/1.70mm Green Chain Link	25m	£151.20
1200mm x 50mm x 3.15/2.24mm Green Chain Link	25m	£189.60



From
£58.80

WELD MESH

SPECIFICATION	LENGTH	COST
900mm x 13mm x 13mm x 19g Galv Welded Mesh	6m	£53.10
900mm x 13mm x 25mm x 19g Galv Welded Mesh	6m	£45.18
900mm x 25mm x 25mm x 19g Galv Welded Mesh	6m	£31.08
900mm x 50mm x 50mm x 16g Galv Welded Mesh	6m	£39.30
900mm x 50mm x 50mm x 16g Galv Welded Mesh	30m	£158.40



From
£31.08

PLAIN WIRE

SPECIFICATION	LENGTH	COST
2.50mm Mild Steel	650m	£61.91
3.15mm Mild Steel	410m	£61.91
2.50mm High Tensile	650m	£64.34
3.15mm High Tensile	410m	£64.34



From
£61.91

WIRE TENSIONING

SPECIFICATION	COST
Barb Wire Gripples per 10	£36.40
Medium Gripples per 20	£20.83
Medium Gripples per 400	£322.56
Large Gripples per 10	£19.85
T-Clip Gripple per 20	£20.83
Galvanised Fence Clips per 1000	£16.13
Galv. Fence Clips Hog Ring/CL	£16.70
Hayes HC2 Crimp Sleeves (Pack 100)	£37.85
Hayes HC3 Crimp Sleeves (Pack 50)	£34.18

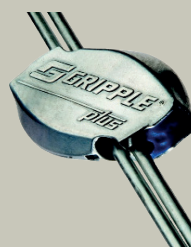

From
£20.83

BARB WIRE

SPECIFICATION	LENGTH	COST
2.50mm Mild Steel (Tornado)	200m	£48.60
2.00mm High Tensile (Tornado)	200m	£47.05
2.50mm Mild Steel (Estate Wire)	200m	£47.04
2.00mm High Tensile (Barracuda)	200m	£43.68



SLOTTED CORNER POSTS

SPECIFICATION	COST
2.40m x 125mm x 125mm	£45.47
2.70m x 125mm x 125mm	£47.82

Our steel reinforced concrete Slotted Corner Posts have a section size of 125mm x 125mm and are designed to have two fence panels slotted in at 90 degrees.



From
£45.47

SLOTTED T- POST

SPECIFICATION	COST
2.40m x 125mm x 125mm	£49.71
2.70m x 125mm x 125mm	£51.28

T-posts have a section size of 125mm x 125mm and are designed to have three panels slotted in a T-Shape. Like all our Concrete Posts, these are wet poured for a smooth appearance.



From
£49.71

SLOTTED END POSTS

SPECIFICATION	COST
2.40m x 125mm x 100mm	£35.05
2.70m x 125mm x 100mm	£35.86

Available in varying lengths, our Concrete End Posts are U-Shaped with a section size of 125mm x 100mm and are designed to have a panel slotted on one side.



From
£35.05

AGGREGATES

SPECIFICATION	COST
20Kg Bag of Postmix	£6.59

YORKSHIRE WALLING

SPECIFICATION	COST
1.83m x 300mm	£27.96



SMOOTH FACED GRAVEL BOARD

SPECIFICATION	COST
1.83m x 150mm	£17.54
1.83m x 300mm	£25.46
3.00m x 150mm (recessed posts)	£33.04

SLOTTED INTER POSTS

SPECIFICATION	COST
1.50m x 125mm x 100mm	£26.92
1.80m x 125mm x 100mm	£27.68
2.10m x 125mm x 100mm	£28.40
2.40m x 125mm x 100mm	£29.00
2.70m x 125mm x 100mm	£30.08
3.00m x 125mm x 100mm	£39.24

UNIVERSAL POST

SPECIFICATION	COST
2.40m x 100mm x 100mm	£34.70

REPAIR SPUR

SPECIFICATION	COST
1.05m x 100mm x 100mm	£16.21

RECESSED POST

SPECIFICATION	COST
2.40m x 125mm x 100mm	£41.02

FENCEMATE® DuraPost®



Fencemate's Durapost is a fencing alternative to Concrete, Wooden Posts and Gravel Boards. Weighing in at 7.2kg Fencemate Durapost is 80% lighter than concrete making it easier and more efficient to install.

DuraPost is made in the UK from galvanised steel with a wide range of contemporary colours. Patented and Registered Design Protected, it is 100% recyclable at end-of-life, giving you a sustainable choice for your fence. Unlike traditional fence posts, DuraPost won't rot, warp or crack and is maintenance free. That's why DuraPost give their products up to a 25-year guarantee.

With a wide range of colours, styles and with matching accessories, you can create a truly unique, long-lasting and stylish garden with DuraPost.

DURAPOST

SPECIFICATION	COST
2.4m Classic Intermediate - Galvanised	£26.57
2.4m Classic Intermediate (Choice of colours)	£40.05
2.7m Classic Intermediate - Galvanised	£32.01
2.7m Classic Intermediate (Choice of colours)	£48.13
3.0m Classic Intermediate - Galvanised	£35.99
3.0m Classic Intermediate (Choice of Colours)	£53.47
2.4m 75mm Gate Post (Choice of colours)	£66.74
2.4m 75mm Gate Post - Galvanised	£53.47
1.83m Composite Gravelboard	£22.79

From
£40.05



DURAPOST ACCESSORIES

SPECIFICATION	COST
1.8m U Channel - Galvanised	£14.56
1.8m U Channel (Choice of colours)	£22.60
3.0m U Channel - Galvanised	£25.27
3.0m U Channel (Choice of colours)	£40.05
1.8m Capping Rail (Choice of colours)	£26.63
75mm x 75mm Post Cap (Choice of colours)	£3.98
Dura Touch Up Spray (Choice of colours)	£17.34
Pan Head Timber Screws (Choice of Colours)	£4.15
DuraPost Bolt Down Galv	£19.67

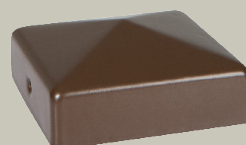

From
£26.63



SAWN & TREATED POSTS

SPECIFICATION	75MM X 75MM	100MM X 100MM
1.50m length	£6.97	£10.97
1.80m length	£8.38	£13.16
2.10m length	£9.78	£15.35
2.40m length	£11.18	£17.55
2.70m length	£12.57	£19.74
3.00m length	£13.95	£21.92
3.60m length	-	£26.31



From
£6.97

Used to support wooden fencing systems, our Sawn Softwood Fence Posts are pressure treated on site using Tanalith E, a market leader in its field to ensure longevity. Non-standard sizes and hardwood posts are also available to order.

POSTSAVERS

SPECIFICATION	COST
Standard Post Saver	£3.72
Large Post Saver	£5.60
Extra Large Post Saver	£6.91

PALISADE PALES

SPECIFICATION	COST
900mm Pointed Top	£1.88
1200mm Pointed Top	£2.50
900mm Round Top	£1.88
1200mm Round Top	£2.50

From
£1.88

Used to create a picket style fence, our finished softwood treated Palisade Pales are available in either a pointed or round top.



FEATHER EDGE

SPECIFICATION (EX 22MM)	COST
1.05m x 150mm	£1.23
1.35m x 150mm	£1.58
1.65m x 150mm	£1.89
1.80m x 150mm	£2.08
2.10m x 150mm	£2.42
2.40m x 150mm	£2.77
3.00m x 150mm	£3.47
3.60m x 150mm	£4.14
1.05m x 125mm	£1.00
1.20m x 125mm	£1.14
1.35m x 125mm	£1.29
1.50m x 125mm	£1.46
1.65m x 125mm	£1.60
1.80m x 125mm	£1.72

Our pressure treated Feather Edge Boards are cut from ex 22mm sawn timber and are available in a width of 150mm & 125mm.

We recommend a minimum 25mm overlap when being used for Closeboard Fencing.



From
£1.00



RAILS

SPECIFICATION	COST
3.66m x 87mm x 38mm Rails	£8.64
4.80m x 87mm x 38mm Rails	£11.33
3.66m x 87mm x 38mm Weathered Rails	£10.50

From
£10.50



POST CAPS

SPECIFICATION	COST
To fit 75mm Posts	£1.31
To fit 100mm Posts	£1.94

From
£1.31

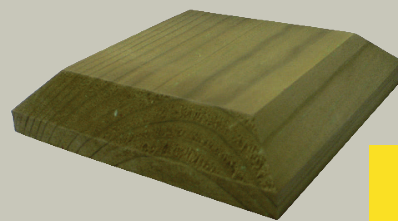

CAPPING

SPECIFICATION	COST
3.60m 65mm x 38mm Capping	£8.33
3.60m 65mm x 38mm Rebated Capping	£10.20
1.83m 65mm x 18mm Capping	£2.50

As well as providing a decorative finish to your fence, our Fence Capping also prevents water getting into the end grain of your Fence Boards. The Rebated Capping has a groove in the underside that fits over the top of Feather Edge Boards to provide a weather tight finish.



GRAVEL BOARD

SPECIFICATION	COST
1.83m x 150mm x 22mm	£4.17
3.00m x 150mm x 22mm	£6.84
3.66m x 150mm x 22mm	£8.34
4.20m x 150mm x 22mm	£9.58
4.80m x 150mm x 22mm	£10.94

Used to raise fence panels or closeboard off the ground, our pressure treated wooden Gravel Boards aid in the protection of damage that moisture ingress can cause.

From
£4.17



FENCE PANELS

PANELS	1.83M W X 1.83M H	1.83M W X 1.52M H	1.83M W X 1.22M H	1.83M W X 0.91M H	1.83M W X 0.61M H
Herringbone	£85.40	£78.96	£71.19	£63.45	£55.67
Herringbone Convex	£106.74	£98.70	£88.99	£79.32	£69.59
Venetian Panel	£119.54	£105.56	£91.58	£72.97	£58.98
Closeboard with/without Gravel Board	£50.95	£47.32	£45.20	£41.63	£36.87
Closeboard Convex/Concave	£63.68	£59.15	£56.60	£52.05	£46.10
Closeboard with 300mm Square Trellis	£76.73	£74.29	£70.18	£64.71	-
Closeboard with 300mm Diamond Trellis	£99.06	£96.60	£92.49	£87.02	-
Yarcombe Overlap	£37.49	£36.58	£33.81	£31.80	£29.36
Yarcombe Overlap with 300mm Square Trellis	£64.38	£61.19	£58.88	£56.07	-
Rustic	-	£102.34	£97.31	£77.48	-
Palisade	-	-	£52.64	£42.98	-

HERRINGBONE PANEL
CONVEX

From
£69.59

OVERLAP PANEL
INC. 300MM TRELLIS

From
£56.07

PALISADE PANEL
POINTED TOP

From
£42.98

CLOSEBOARD PANEL
STRAIGHT

From
£36.87



VENETIAN PANEL



From
£58.98

RUSTIC PANEL



From
£77.48

Our Fence Panels are manufactured on site in a purpose built workshop by our skilled local craftsmen and come in various styles. Bespoke sizes can also be manufactured.

EUROPEAN FENCE PANELS

EUROPEAN PANELS	1.8M W X 1.8M H	1.8M W X 1.5M H	1.8M W X 1.2M H	1.8M W X 0.9M H
Oasis Fence Panel	£82.20	£77.80	£70.01	£61.75
Madrid Fence Panel	£99.00	£90.18	£75.95	£66.48
Milano Fence Panel	£63.00	£59.00	-	-

Our European Panels are a stock item which we buy in from a genuine supplier. Durable and decorative, our European Fence Panels are another option for garden boundaries.



From
£61.75

OASIS FENCE PANEL



From
£59.00

MILANO FENCE PANEL



From
£66.48

MADRID FENCE PANEL

CHESTNUT PALISADE PANEL

SPECIFICATION	COST
1.80m x 900mm	£62.45



From
£62.45

CHESTNUT MORTICED POST

SPECIFICATION	COST
1.50m high for Palisade Panel	£10.55



Used for Chestnut Post & Rail Fencing, our Chestnut Morticed Post comes complete with pairs of side by side mortice slots that are ready to insert Chestnut Rails for a quick and efficient fencing solution.

SAWN & TREATED POSTS

SPECIFICATION	75MM X 75MM	100MM X 100MM
1.50m	£6.97	£10.97
1.80m	£8.38	£13.16
2.10m	£9.78	£15.35
2.40m	£11.18	£17.55
2.70m	£12.57	£19.74
3.0m	£13.95	£21.92
3.60m	-	£26.31

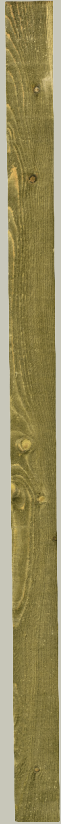

Used to support wooden fencing systems, our sawn softwood fence posts are pressure treated on site using Tanalith E, a market leader in its field to ensure longevity. Non-standard sizes and hardwood posts are also available to order.

CHESTNUT PALING

SPECIFICATION	COST
10m roll of 0.9m high two wire Chestnut Pale Fencing	£87.83
10m roll of 1.2m high three wire Chestnut Pale Fencing	£118.55



From
£87.83

POST CAPS

SPECIFICATION	COST
To fit 75mm Posts	£1.31
To fit 100mm Posts	£1.94



TRELLIS

STANDARD TRELLIS APPROX 4" SQUARES

SPECIFICATION	1.83M W X 0.30M H	1.83M W X 0.61M H	1.83M W X 0.91M H	1.83M W X 1.22M H	1.83M W X 1.52M H	1.83M W X 1.83M H
Square Flat Top	£19.40	£24.95	£29.11	£31.88	£34.65	£36.09
Square Convex/Concave	£26.19	£33.68	£39.29	£43.03	£46.78	£48.72
Diamond Flat Top	£38.80	£49.90	£58.22	£63.76	£69.30	£72.18
Diamond Convex/Concave	£52.38	£67.37	£78.60	£86.08	£93.56	£97.44
Decorative Convex Trellis	-	£29.70	-	-	-	-

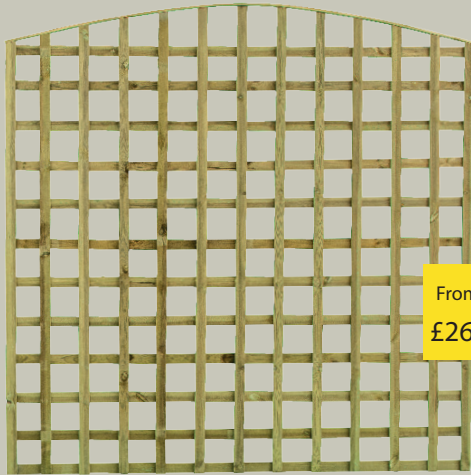

From
£26.19



From
£38.80

POSTMIX

SPECIFICATION	COST
20kg Bag of Postmix	£6.59



FAN TRELLIS

SPECIFICATION	COST
0.61m w x 1.83m h	£29.11
0.91m w x 1.83m h	£30.49
1.22m w x 1.83m h	£31.88



From
£29.11

DECKING BOARDS

SPECIFICATION	COST
3.0m x 125mm x 38mm Treated Decking	£12.20
3.6m x 125mm x 38mm Treated Decking	£14.64
4.2m x 125mm x 38mm Treated Decking	£17.08
4.8m x 125mm x 38mm Treated Decking	£19.52

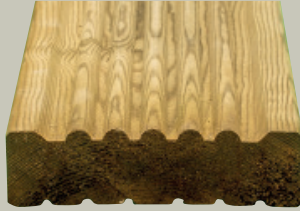

From
£12.20

Attached to the joists to form a deck floor, our Decking Boards are machined from high quality Scandinavian Redwood and are pressure treated to ensure a long lifespan.

HANDRAIL

SPECIFICATION	COST
88mm x 44mm Rebated 33mm	£6.02 per m



Our Decking Handrail is machined from Scandinavian Redwood and is a finished size of 88mm x 44mm. This item is designed to be used as a guard rail and used alongside our decking spindles and base rail.

BASERAIL

SPECIFICATION	COST
70mm x 20mm with 33mm Groove	£3.90 per m



Our Decking Baserail is machined from Scandinavian Redwood and is a finished size of 70mm x 20mm.

DECKING SPACER

SPECIFICATION	COST
33mm x 13mm	£1.27 per m



Our 33mm x 8mm Decking Spacer is designed to be used with our base rail, handrail and spindles.

DECKING JOISTS & POSTS

SPECIFICATION	COST
100mm x 100mm Sawn Timber	£6.63 per m
100mm x 47mm Graded Timber	£3.31 per m
150mm x 47mm Graded Timber	£4.57 per m

Used to create a foundation and framing structure for the decked area. Placed accordingly to support the decking boards.

BALUSTRADE

SPECIFICATION	COST
900mm x 33mm x 33mm	£2.87



From
£2.87

The Balusters are positioned to fill the space between the top and bottom rails and between rail posts.



CLADDING

SPECIFICATION	LENGTH	COST
Pressure Treated Loglap 125mm x 22mm	4.80m	£16.44
Pressure Treated Shiplap 125mm x 12mm	4.80m	£13.58
Pressure Treated Shiplap 144mm x 14mm	3.90m	£12.47
Pressure Treated Shiplap 144mm x 14mm	4.50m	£14.34
Pressure Treated Shiplap 144mm x 14mm	5.40m	£17.24
Pressure Treated TG&V 119mm x 20mm	4.20m	£14.51
Pressure Treated Douglas Fir Waney Edge 225mm x 19mm Average	3.60m	£20.94
Pressure Treated Douglas Fir Waney Edge 225mm x 19mm Average	4.80m	£27.89
Pressure Treated Feather Edge 150mm Ex 22mm	3.60m	£4.14
Pressure Treated Feather Edge 200mm Ex 38mm	3.60m	£11.78
Dung Board 200mm (nom) x 47mm	3.60m	£23.62



From
£20.94

DOUGLAS FIR WAYNEY EDGE

We source our Douglas Fir Wayney Edge locally and pressure treat the timber on site.



From
£4.14

FEATHER EDGE

Feather Edge is a versatile cost effective cladding suited to almost any exterior construction. We pressure treat this timber on site using Tanalith E.



From
£23.62

DUNG BOARD

Also known as stock walling, these boards are used in agriculture where strength is required.



From
£14.51

TG&V

Used for cladding all types of buildings including our own garden sheds. We pressure treat this timber.



ELLUMIERE LIGHTING SYSTEMS

STEP 1		SELECT YOUR LIGHTS	Any style or size MAX 12 LIGHTS PER TRANSFORMER
STEP 2		CHOOSE YOUR CONNECTORS & CABLES	Various lengths MAX 50M PER TRANSFORMER
STEP 3		GRAB A TRANSFORMER	Plug in and enjoy IT'S THAT SIMPLE

Ellumiere is one of the simplest and most effective 12v garden lighting systems available without the need for an electrician.

From deck lights, spotlights and bollards, to transformers, connectors and sensors, we have everything you need to get your garden glowing.

Building your lighting layout in 3 simple steps.

SPOTLIGHTS

SPECIFICATION	COST
Small Stainless Steel Spotlight 2W LED 0.5m Cable, Spike & Base	£30.00
Large Black Spotlight 3W LED 0.5m Cable Spike & Base	£26.00
Small Spotlight Starter Kit. x4 2W Spotlights & x1 100W Transformer	£125.20



BOLLARD LIGHTS

SPECIFICATION	COST
Black Bollard Light 3W 0.5m Spike & Base	£36.91
Stainless Steel Bollard Light 3W 0.5m Cable Spike & Base	£37.98



DECKING LIGHTS

SPECIFICATION	COST
Single Large Deck Light 2W 0.2m Cable	£27.83
Set of 4 Small Decking Lights 1W 0.2m Cable	£63.13
Small Deck Light Starter Kit. x4 1W Deck Lights & 100w Transformer	£112.36



EXTENSION CABLES

SPECIFICATION	COST
1m Extension Cable Male to Female	£5.09
2m Extension Cable Male to Female	£6.31
5m Extension Cable Male to Female	£12.83
10m Extension Cable Male to Female	£19.25

ACCESSORIES

SPECIFICATION	COST
T-Piece Adaptor 2 Pin 3 Way	£3.85
Automatic Light Sensor 100W	£19.25
100W Outdoor Transformer 240V AC>12V	£33.17

WEED & GROUND CONTROL

PERMATEX GROUND CONTROL

SPECIFICATION	COST
15m x 1m	£16.36
25m x 2m	£37.42



From
£16.36

WEED CONTROL

SPECIFICATION	COST
20m x 1m	£18.45



From
£18.45



SLEEPERS

SPECIFICATION	COST
New Treated Softwood 2.40m x 200mm x 100mm	£26.50
New Treated Softwood 2.40m x 250mm x 125mm	£41.45
Freshly Sawn Oak 2.40m x 200mm x 100mm	£48.00
Reclaimed Hardwood Grade 1 approx 2.60m x 250mm x 150mm	£47.88



SAWN PEGS & TREE STAKES

SPECIFICATION	COST
450mm x 38mm x 38mm	£1.01
600mm x 38mm x 38mm	£1.40
450mm x 50mm x 50mm	£1.40
600mm x 50mm x 50mm	£1.52
1.20m x 32mm x 32mm	£1.84
1.50m x 32mm x 32mm	£1.95

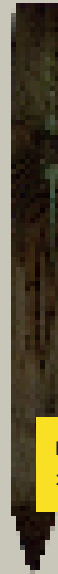

From
£1.01



From
£1.84



PRESSURE TREATED TIMBER

MM	1.5	1.8	1.83	2.1	2.4	2.7	3.0	3.6	3.66	4.2	4.8	6.1	METRE
38 x 16			X										£1.03
38 x 19								X					£1.08
38 x 38	X		X										£1.42
50 x 25 PAR								X					£2.10
50 x 25								X					£1.66
50 x 47 Graded					X		X	X					£2.22
75 x 22			X					X					£1.63
75 x 47 Graded							X	X			X		£2.28
75 x 75	X	X		X	X	X	X						£4.43
87 x 38									X		X		£2.36
87 x 38 Weathered									X				£2.87
87 x 38 Graded											X		£2.36
90 x 13									X				£1.42
100 x 22								X					£2.17
100 x 47								X			X		£3.11
100 x 47 Graded					X		X	X		X	X		£3.11
100 x 75								X					£6.16
100 x 100	X	X		X	X	X	X	X					£6.96
125 x 22								X					£2.57
125 x 125				X	X	X	X						£14.76
150 x 22			X				X		X	X	X		£2.28
150 x 47								X			X		£4.57
150 x 47 Graded							X	X			X		£4.57
150 x 75											X	X	£9.46
150 x 150				X	X	X	X						£21.34
175 x 22								X					£3.81
175 x 47								X			X	X	£6.55
175 x 75											X	X	£11.03
175 x 175				X	X	X	X						£28.96
200 x 22								X					£4.35
200 x 38								X					£7.42
200 x 47								X				X	£8.18
200 x 75											X	X	£12.60
200 x 100												X	£15.95
200 x 200				X	X	X	X						£37.11
225 x 75											X		£17.64
225 x 100											X	X	£18.87
300 x 47											X		£12.40



GARDEN GATES

STYLES	0.91M W X 0.91M H	0.91M W X 1.22M H	0.91M W X 1.52M H	0.91M W X 1.83M H
Closeboard				
Straight Top	£88.06	£96.87	£109.18	£122.91
Convex	£110.08	£121.09	£136.48	£153.64
Overlap				
Straight Top	£88.06	£96.87	£109.18	£122.91
Trellis				
Straight Top	£90.54	£106.11	£120.71	£139.96
Nailed Palisade				
Straight Top Round/Pointed	£51.06	£63.02	£89.82	£107.13
Convex	£63.83	£78.78	£112.28	£133.91
Morticed Palisade				
Straight Top Flat/Round/Pointed	£135.92	£167.75	£194.59	£248.00
Convex	£163.12	£201.31	£233.50	£297.60
Ledged & Braced				
Straight Top	£79.11	£105.48	£131.86	£158.21
Convex	£94.93	£126.58	£158.23	£189.85
Framed Ledged & Braced				
Straight Top	£153.44	£204.58	£255.83	£306.86
Chestnut Palisade Gate With Posts	£115.10			-

FRAMED LEDGED
& BRACED GATE

From
£153.44

CHESTNUT
PALISADE GATE

From
£115.10

Our wide range of Garden Gates are manufactured on site by skilled local craftsmen in our purpose built workshop. Excluding our Chestnut Palisade Gate, all our gates are pressure treated using Tanalith E Preservative to ensure a long lasting product. Bespoke sizes can also be manufactured. Various gate fixture and fittings can also be purchased to ensure a complete finish.



CLOSEBOARD GATE



From
£88.06

OVERLAP GATE



From
£88.06

TRELLIS GATE

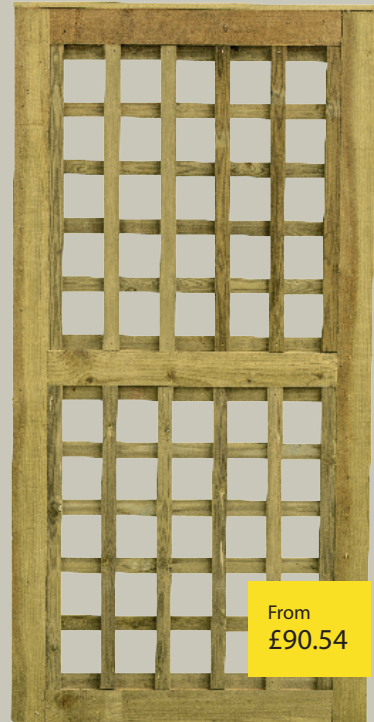

From
£90.54

NAILED PALISADE GATE CONVEX



From
£63.83

MORTICED PALISADE GATE POINTED TOP



From
£135.92

LEDGED & BRACED GATE CONVEX

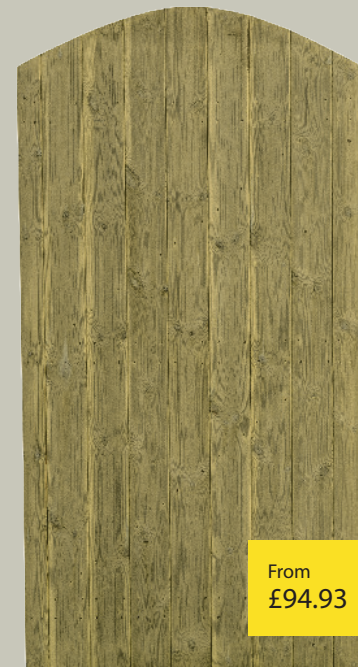

From
£94.93



DRIVEWAY GATES

PER GATE LEAF	CHINNOCK/ FL&B	KINGSTONE / WAYFORD/WHOBERLEY	HERRINGBONE/ LAMBROOK/CONVEX	MORTICED PALISADE
0.91m w x 0.91m h	£153.44	£171.96	£181.96	£135.92
0.91m w x 1.22m h	£204.58	£229.24	£242.57	£167.75
0.91m w x 1.52m h	£255.76	£286.58	£303.25	£194.59
0.91m w x 1.83m h	£306.86	£343.86	£363.88	£248.00
1.22m w x 0.91m h	£204.58	£229.24	£242.57	£181.20
1.22m w x 1.22m h	£272.76	£305.66	£327.80	£223.65
1.22m w x 1.52m h	£340.98	£382.07	£404.31	£277.15
1.22m w x 1.83m h	£409.18	£458.46	£485.16	£330.70
1.52m w x 0.91m h	£255.76	£286.58	£303.25	£226.50
1.52m w x 1.22m h	£340.98	£382.07	£404.31	£279.55
1.52m w x 1.52m h	£426.20	£492.16	£505.40	£346.43
1.52m w x 1.83m h	£511.51	£573.10	£606.46	£413.44
1.83m w x 0.91m h	£306.86	£343.86	£363.88	£271.80
1.83m w x 1.22m h	£409.18	£458.46	£485.16	£335.50
1.83m w x 1.52m h	£511.51	£573.10	£606.46	£415.76
1.83m w x 1.83m h	£613.73	£687.70	£727.74	£496.05
2.13m w x 0.91m h	£358.20	£401.16	£425.53	n/a
2.13m w x 1.22m h	£477.35	£534.89	£566.03	n/a
2.13m w x 1.52m h	£596.72	£668.65	£707.53	n/a
2.13m w x 1.83m h	£716.02	£767.69	£849.06	n/a

MORTICED PALISADE



From
£135.92

HERRINGBONE



From
£181.96

Enhance the entrance to your home, by fitting one of our high quality Timber Driveway Gates. All our gates are made from Scandinavian Redwood and 19mm TG&V, and once manufactured they are brush treated to protect and prolong their lifespan. Standard styles and sizes are manufactured to order, though bespoke sizes and designs can be created to your specifications.



CHINNOCK



From £153.44

KINGSTONE

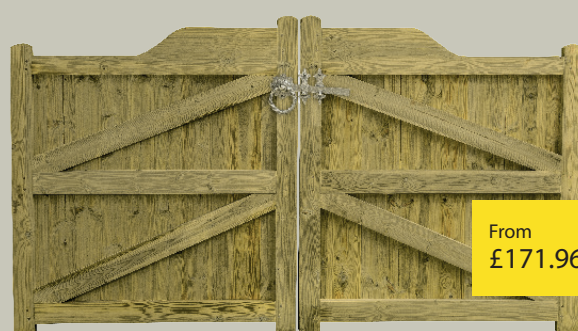

From £171.96

LAMBROOK

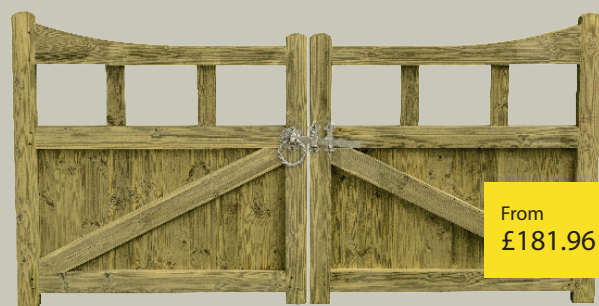

From £181.96

WHOBERLEY



From £171.96

WAYFORD



From £171.96

FIELD GATES

WIDTH	UNIVERSAL 5 BAR GATE	DIAMOND BRACED	TURNED HEEL	HINTON	PERSONEL	CROSS BRACED
0.79m	-	-	-	-	£119.70	£132.50
0.91m	£87.22	-	-	-	£119.70	£132.50
1.22m	£91.27	-	-	-	£132.30	£144.91
1.40m	-	-	-	-	£157.50	£170.11
1.52m	£100.04	-	-	-	£157.50	£170.11
1.83m	£106.38	£194.04	£252.25	£174.04	-	-
2.13m	£112.43	£201.01	£262.08	£181.45	-	-
2.44m	£130.32	£209.17	£271.91	£188.24	-	-
2.74m	£136.69	£216.73	£281.74	£195.06	-	-
3.05m	£143.05	£224.29	£291.56	£201.85	-	-
3.35m	£156.19	£229.53	£298.12	£206.39	-	-
3.66m	£158.58	£234.99	£305.49	£211.49	-	-

DIAMOND BRACED GATE



From
£194.04

Our Five Bar Gates are all handcrafted on site using locally sourced Douglas Fir in a variety of styles.

Our gates are bespoke and can be made to your specification, but we also stock standard sizes.

HINTON GATE



From
£174.64

All our gates are finished to a high standard using stainless steel bolts and are pressure treated to ensure a long life span. To complement our gates we also hold a wide range of fixtures and fittings.

TURNED HEEL GATE



From
£252.25

CROSS BRACED GATE



From
£132.30

GALVANISED GATES

GATE WIDTH	STANDARD	HALF MESH
0.91m	£78.12	£105.29
1.22m	£92.61	£124.88
1.52m	£100.17	£131.63
1.83m	£107.10	£150.59
2.13m	£114.66	£156.62
2.44m	£131.04	£166.75
2.74m	£133.56	£175.16
3.05m	£124.55	£177.22
3.35m	£152.46	£188.67
3.66m	£139.73	£199.15
3.96m	£175.14	£219.05
4.27m	£172.62	£232.24
4.57m	£168.65	£243.01
4.88m	£197.82	£259.90
Bolt on D-Loop		£12.60
Drop Bolt		£45.78



From
£74.40

Available in various styles and sizes, we are able to order a wide range of LM Bateman Galvanised Gates and products. We also hold in stock varying sizes of the Ashcombe Gate; a seven bar Galvanised Field Gate, 1145mm high, complete with box section braces. Please note our Half Mesh Gates are not a stock item and will need to be ordered from our supplier.

WOODEN GATE POSTS

SPECIFICATION	SUITABLE FOR GATE WIDTHS	2.1M	2.4M	2.7M	3.0M
125mm x 125mm	0.79m – 1.52m	£31.00	£35.54	£39.83	£44.37
150mm x 150mm	1.70m – 2.74m	£44.79	£51.20	£57.59	£63.99
175mm x 175mm	3.05m – 3.66m	£60.87	£69.68	£78.21	£88.18
200mm x 200mm	3.05m – 3.66m	£77.92	£88.98	£99.87	£111.79

HANG POST

SPECIFICATION	COST
2m x 88.9mm dia.	£59.03
2m x 114.3mm dia.	£83.16

SLAM POST

SPECIFICATION	COST
2m x 88.9mm dia.	£54.18
2m x 114.3mm dia.	£67.03

AUTO CATCH SLAM POST

SPECIFICATION	COST
2m x 88.9mm dia.	£65.52
2m x 114.3mm dia.	£91.98

LOOP OVER

SPECIFICATION	COST
Loop Over 750mm	£44.73
Heavy Duty Loop Over 860mm	£100.17



GARDEN GATE FITTINGS

SPECIFICATION	COST
Pair of 450mm Tee Hinges	£19.38
Pair of 400mm Tee Hinges	£13.32
Pair of 350mm Tee Hinges	£11.98
Medium Auto Catch	£5.66
Large Auto Catch	£10.26
150mm Twisted Ring Latch	£18.48
Suffolk Latch	£21.42
200mm Self Closing Gate Spring	£18.42
250mm Self Closing Gate Spring	£23.16
150mm Brenton Bolt	£9.02
Side Gate Kit	£38.81

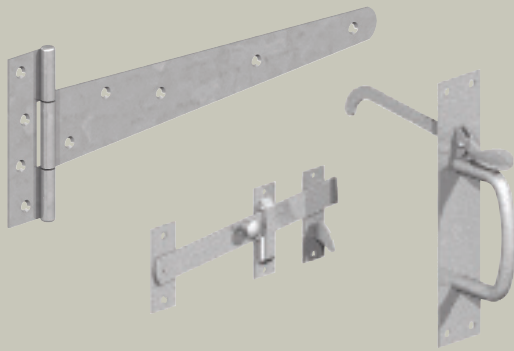

DRIVEWAY GATE FITTINGS

SPECIFICATION	COST
Pair of 900mm Adjustable Hook and Band	£99.74
Pair of 750mm Adjustable Hook and Band	£84.90
Pair of 600mm Adjustable Hook and Band	£52.80
Pair of 450mm Adjustable Hook and Band	£49.02
Pair of 900mm Straight Hook and Band	£63.90
Pair of 750mm Straight Hook and Band	£52.80
Pair of 600mm Straight Hook and Band	£43.02
Pair of 450mm Straight Hook and Band	£30.90
Pair of 300mm Straight Hook and Band	£24.84
Pair of 750mm Cranked Hook and Band	£53.10
Pair of 600mm Cranked Hook and Band	£43.08
Pair of 450mm Cranked Hook and Band	£30.78
Pair of 750mm Reversible Hook and Band	£81.00
Pair of 600mm Reversible Hook and Band	£59.70
Pair of 450mm Reversible Hook and Band	£39.42
450mm Drop Down Bolt	£18.11
Large Heavy Duty Twisted Ring Latch	£86.40
Long Throw Lock Double Locking 50mm	£62.40
Long Throw Lock Double Locking 70mm	£66.00
200mm Brenton Bolt	£10.10

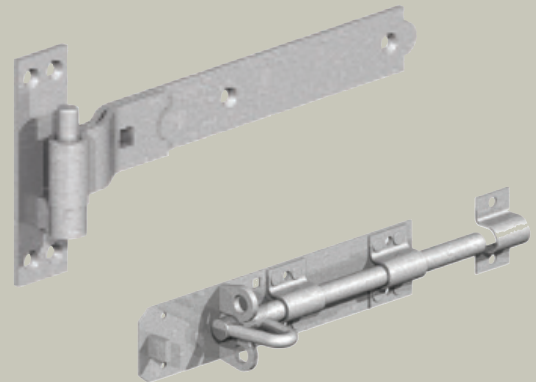

FIELD GATE FITTINGS

SPECIFICATION	COST
610mm Adjustable Field Gate Set with Hook to Drive/Bolt	£34.20
450mm Adjustable Field Gate Set with Hook to Drive/Bolt	£33.00
610mm Adjustable Field Gate Set with Hook on Plate	£40.20
Galv. Spring Fastener Set	£23.82
Cranked Striker	£6.66
D Striker	£8.06
Self Locking Catch	£11.53
Hunting Gate Catch	£22.80
450mm Drop Down Bolt	£18.11
350mm Loop Over Bar	£14.10
350mm Loop Over Bar with handle	£19.44
450mm Lockable Loop Over Bar	£30.00



POST ANCHORS

BROWN	DRIVE IN	BOLT DOWN	REPAIR
50mm x 50mm	£9.86	£8.14	-
75mm x 75mm	£12.12	£9.00	£11.66
100mm x 100mm	£18.30	£10.62	£14.40

GALVANISED	DRIVE IN	BOLT DOWN	REPAIR
75mm x 75mm	£13.80	£11.26	-
100mm x 100mm	£19.08	£13.20	-

BIRKDALE POST ANCHOR REPAIR SPUR POSTS		
1m	Metal Repair Spur Post	£15.34
1.2m	Metal Repair Spur Post	£17.26



ROPE

SPECIFICATION	COST
3 Strand Manila Rope (6m)	£40.69
3 Strand Manila Rope (12m)	£75.92
3 Strand Polyhemp Rope (6m)	£48.79
3 Strand Polyhemp Rope (12m)	£96.13



ROPE FITTINGS

SPECIFICATION	COST
24mm Brass Hook on Eyeplate	£20.90
24mm Chrome Hook on Eyeplate	£22.25
24mm Brass Rope Ends (Pack of 2)	£25.94
24mm Chrome Rope Ends (Pack of 2)	£27.37
24mm -28mm Chrome Handrail Brackets (Pack of 2)	£25.72



POST CAPS & FINIALS

SPECIFICATION	75MM	100MM
Wooden Post Cap	£1.31	£1.94
Wooden Ball Finial	£6.70	£12.78
Wooden Acorn Finial	£6.70	£12.78
Metal Post Cap (Galvanised or Black)	£2.52	£3.84
Metal Ball Finial (Galvanised or Black)	£5.06	£7.07



YARCOMBE SHED RANGE

THE GARDENER

Apex Style Shed. Single door to the front. Single 610mm x 610mm Glass Window (Choice of Side Panel). Any Cladding. Galvanised Fittings. Brenton Padbolt. TG&V Roof & Floor. Green Polyester Felt Roof. 75mm x 75mm Bearers. 50mm x 47mm Framework. Brush Treated with a Clear Sovereign Preservative. Internally fitted with a breathable membrane.



SPECIFICATION	SHIPLAP 14MM	LOGLAP 22MM	TG&V 19MM
1.83m x 1.22m	£887.04	£963.65	£1040.83
2.13m x 1.52m	£1208.76	£1314.60	£1420.02
2.44m x 1.83m	£1376.06	£1496.45	£1617.41
3.05m x 2.44m	£2113.20	£2320.32	£2507.52

From
£887.04

THE GROUNDSMAN

Pent Style Shed. Single door to the front. Single 610mm x 610mm Glass Window to the front, right hand side of the door. Any Cladding. Galvanised Fittings. Brenton Padbolt. TG&V Roof & Floor. Green Polyester Felt Roof. 75mm x 75mm Bearers. 50mm x 47mm Framework. Brush Treated with a Clear Sovereign Preservative. Internally fitted with a breathable membrane.



SPECIFICATION	SHIPLAP 14MM	LOGLAP 22MM	TG&V 19MM
1.83m x 1.22m	£887.04	£963.65	£1040.83
2.13m x 1.52m	£1208.76	£1314.60	£1420.02
2.44m x 1.83m	£1376.06	£1496.45	£1617.41
3.05m x 2.44m	£2113.20	£2320.32	£2507.52

From
£887.04



THE CRAFTSMAN

Pent Style Security Shed. Double doors to the front. 3no 305mm x 610mm Glass Windows at the top on the high side panel on the right hand side of the doors. Any Cladding. Black Fittings. Long Throw Morticed Lock. TG&V Roof & Floor. Green Polyester Felt Roof. 75mm x 75mm Bearers. 50mm x 47mm Framework. Brush Treated with a Clear Sovereign Preservative. Internally fitted with a breathable membrane.



SPECIFICATION	SHIPLAP 14MM	LOGLAP 22MM	TG&V 19MM
3.05m x 2.44m	£2475.12	£2662.32	£2849.52
3.66m x 2.44m	£2901.74	£3126.38	£3351.02
4.26m x 2.44m	£3328.37	£3590.45	£3852.53

From
£2475.12

THE BOTANIST

Pent Style Potting Shed. Sloped Front. 6no Glass Windows (approx 610mm x 610mm) to the front. Single Stable Door on the side panel to the right of the front windows. Single 610mm x 610mm Opening Glass Window opposite end to the door. Fitted Internal Workbench. Any Cladding. Galvanised Fittings. Brenton Padbolt. TG&V Roof & Floor. Green Polyester Felt Roof. 75mm x 75mm Bearers. 50mm x 47mm Framework. Brush Treated with a Clear Sovereign Preservative. Internally fitted with a breathable membrane.



SPECIFICATION	SHIPLAP 14MM	LOGLAP 22MM	TG&V 19MM
1.83m x 1.22m	£1187.04	£1263.65	£1340.83
2.13m x 1.52m	£1508.76	£1614.60	£1720.02
2.44m x 1.83m	£1676.06	£1796.45	£1917.41
3.05m x 2.44m	£2433.12	£2620.32	£2807.52

From
£1187.04

YARCOMBE SUMMERHOUSE RANGE

THE HINTON

Apex Style Summerhouse. Double Doors to the front incorporating long glass windows. 4no Long Glass windows, 2no either side of doors and 2no on side panels. 450mm Canopy. Ornate Black Fittings. Long Throw Morticed Lock. Any Cladding. TG&V Floor & Roof. Green Polyester Felt Roof. 75mm x 75mm Bearers. 50mm x 47mm Framework. Brush Treated with a Clear Sovereign Preservative. Option to fit with internal breathable membrane.



From
£2344.47

THE MONTACUTE

Corner Style Pent Summerhouse. Double Doors to the front incorporating long glass windows. 2no Long Glass windows on side panels, with small opening quarter light. Ornate Black Fittings. Long Throw Morticed Lock. Any cladding. TG&V Floor & Roof. Green Polyester Felt Roof. 75mm x 75mm Bearers. 50mm x 47mm Framework. Brush Treated with a Clear Sovereign Preservative. Option to fit with a internal breathable membrane.



From
£2454.90

THE BARRINGTON

Pent Style Summerhouse. Double Doors to the front incorporating long glass windows. 4no Long Glass windows, 2no either side of doors and 2no on side panels, all of which include small opening quarter lights. 450mm Canopy. Ornate Black Fittings. Long Throw Morticed Lock. Any Cladding. TG&V Floor & Roof. Green Polyester Felt Roof. 75mm x 75mm Bearers. 50mm x 47mm Framework. Brush Treated with a Clear Sovereign Preservative. Option to fit with a internal breathable membrane.



From
£2476.47



THE HINTON

SPECIFICATION	SHIPLAP 14MM	LOGLAP 22MM	TG&V 19MM
2.44m x 1.83m	£2344.47	£2423.65	£2450.26
2.44m x 2.44m	£2958.34	£3059.44	£3093.30
2.74m x 1.83m	£2576.92	£2654.96	£2684.22
3.05m x 2.44m	£3504.24	£3624.19	£3664.51

THE MONTACUTE

SPECIFICATION	SHIPLAP 14MM	LOGLAP 22MM	TG&V 19MM
2.13m x 2.13m	£2454.90	£2535.46	£2565.65
2.44m x 2.44m	£3093.62	£3196.78	£3231.45
2.74m x 2.74m	£3787.50	£3915.02	£3957.88
3.05m x 3.05m	£4422.30	£4572.24	£4622.64

THE BARRINGTON

SPECIFICATION	SHIPLAP 14MM	LOGLAP 22MM	TG&V 19MM
2.44m x 1.83m	£2476.47	£2555.65	£2582.26
2.44m x 2.44m	£3084.62	£3185.44	£3219.30
2.74m x 1.83m	£2696.92	£2783.96	£2813.22
3.05m x 2.44m	£3624.24	£3744.19	£3784.51

Here at Yarcombe Woodland Products we offer a variety of Summerhouse styles and finishes varying from the traditional to the ultra-modern. All our Summerhouses are manufactured in our purpose-built workshop by our skilled staff and bespoke options can be explored to include UPVC Windows & Doors.

Please note these and any additional add on's or bespoke sizes are at an additional cost and an estimate can be drawn up.

Similarly to our Sheds; all our Summerhouses come with Free Local Delivery within 30 miles of our location and installation options are available.



PROTEK PAINT RANGES

Protek Royal Exterior Paint. Superior Wood Protection & Colour. A Hard Wearing & Water Repelling Coating.

With over 60 Colours to choose from we are able to order in any colour of your choice up to 25L from our suppliers. We stock some of the most popular colours, though delivery of other colour choices are available. Yarcombe Woodland Products can also offer a Shed/Summerhouse Painting service, attentively decorated by one of our workshop team, prior to your Shed/Summerhouse being delivered at an additional cost.

ROYAL EXTERIOR PAINT

SPECIFICATION	COST
Royal Exterior 2.5L Warm Clay	£46.20
Royal Exterior 2.5L China Clay	£46.20
Royal Exterior 2.5L Golden Oak	£46.20
Royal Exterior 2.5L Mendip Mist	£46.20
Royal Exterior 2.5L Priddy Pools	£46.20
Royal Exterior 2.5L Sage Leaf	£46.20
Royal Exterior 2.5L Somerset Blue	£46.20
Royal Exterior 2.5L Walnut	£46.20

SHED/FENCE STAIN

SPECIFICATION	COST
Shed/Fence Stain 5L Golden Brown	£12.60
Shed/Fence Stain 5L Moss Green	£12.60
Shed/Fence Stain 5L Nut Brown	£12.60
Shed/Fence Stain 5L Russet	£12.60

DECKING STAIN

SPECIFICATION	COST
Protek Decking Stain 2.5L Nut Brown	£32.40
Protek Decking Stain 2.5L Grey	£32.40
Protek Decking Stain 2.5L Rustic Oak	£32.40
Protek Decking Stain 2.5L Clear	£32.40

ECO SHIELD PAINT

SPECIFICATION	COST
Protek ECO Shield 2.5L Clear	£26.40
Protek ECO Shield 2.5L Dark Brown	£26.40
Protek ECO Shield 2.5L Golden Oak	£26.40
Protek ECO Shield 2.5L Moss Green	£26.40

ROYAL EXTERIOR PAINT COLOURS



DECKING
STAIN

ROYAL
EXTERIOR

SHED AND
FENCE

TIMBER ECO
SHIELD





A BESPOKE SERVICE

Yarcombe Woodland Products take great pride in specialising in high quality bespoke garden sheds that are manufactured on site to order, in both standard and non-standard sizes. Including Summerhouses & Potting Sheds.

Our helpful and friendly team will aid you in designing a shed or summerhouse to suit your needs, and can guide you through your preferred options.

All of our Sheds & summerhouses are manufactured in untreated timber and are then brush treated with clear high quality preservative. Other options such as security windows, stable doors and canopies can also be selected on order.

We also offer a shed painting service, using high quality paint, in a wide variety of colours.

The apex or pent roof can be finished with a high quality polyester felt or Coroline Sheeting choice.

Options to add more windows or opening glass windows are also available.

We offer a choice of cladding; 14mm Shiplap, 22mm Loglap or 19mm TG&V. Though regardless of the Cladding chosen the floor & roof is manufactured using TG&V.

All our sheds as standard are fitted with an internal breathable membrane. This gives effective additional protection to water leaks, created by natural timber movement. This can also be fitted to Summerhouses if required.

With all our Sheds & Summerhouses the internal structure is made from quality 50mm x 47mm graded timber to ensure a robust framework.

Further specialist services include free local delivery on all Shed orders within a 30 mile radius of TA17 8TN and we can also offer an erection service on a prepared base for those that wish to take advantage of our full resources.



WOODEN FIELD SHELTER

SPECIFICATION	COST
2.44m wide x 2.44m deep	£1320.00
3.05m wide x 3.05m deep	£1440.00
3.66m wide x 3.66m deep	£1560.00
4.8m wide x 3.66m deep	£1740.00

Our Field Shelters are made using 87mm x 38mm framing and clad using 150mm x 22mm ex featheredge. All timbers are pressure treated with Tanalith E. The roof is an apex design with an overhang constructed using metal box section profile roofing sheets. The inside is lined upto 1.2m with 12mm ply kickboards.

Bespoke sizes can also be manufactured. Please speak to one of our team to discuss further.



WOODEN DOG KENNEL

SPECIFICATION	COST
0.9m wide x 0.9m deep x 1.07m high	£327.17

Wooden Dog Kennel made with 20mm TG&V with Black Coroline Sheet Roofing.



BIN STORES

SPECIFICATION		COST
Shiplap	1.35m x 0.91m x 1.52m	£489.60
TG&V	1.35m x 0.91m x 1.52m	£549.60



Our Rectangular Bin Stores are incorporated with a single internal shelf and finished with a Heavy Duty Felt Roof, Galvanised Door Fixtures & Fittings and brush treated with a Clear Sovereign Preservative. Bespoke sizes also available. Supplied as a Flat Pack.

LOG STORES

SPECIFICATION		COST
0.91m x 0.61m x 1.52m		£273.62
1.22m x 0.61m x 1.52m		£293.07
1.52m x 0.61m x 1.52m		£317.01
1.83m x 0.61m x 1.52m		£330.94
Triangular 1.32m x 0.61m x 1.83m		£303.18



From
£273.62

GARDEN CHEST

SPECIFICATION		COST
1.2m x 700mm x 700mm		£330.00
1.5m x 700mm x 700mm		£372.00
1.8m x 700mm x 700mm		£408.00



From
£330.00



From
£303.18

Note: Both Logs Stores are supplied as a Flat Pack.



STANDARD ARCH TRELLIS

SPECIFICATION	SQUARE	DIAMOND
0.91m wide	£325.71	£374.00
1.22m wide	£367.28	£408.87

Our Standard Arches are made using planed timber with a choice of either Diamond or Square Trellis. As each garden is unique arches can be made to meet your exact requirements.



We are able to offer a choice of three designs of roof style for our Standard Arches:

- Flat Top
- Round Top
- Apex Top

Note: Supplied as a Flat Pack.

STANDARD SEATED ARBOUR TRELLIS

SPECIFICATION	SQUARE	DIAMOND
0.91m wide	£443.52	£505.89
1.22m wide	£485.10	£547.47

Providing a focal point for your garden whilst creating a relaxing place to sit, all our seated arbours can be manufactured on site to your specifications. Made from high quality pressure treated timber, we can offer a variety of styles.



We are able to offer a choice of three designs of roof style for our Standard Arbours:

- Chinese Top
- Round Top
- Apex Top

Note: Supplied as a Flat Pack.

WOODEN PERGOLA

SPECIFICATION	COST
SQUARE	
2.40m x 2.40m	£498.00
3.00m x 3.00m	£570.00
3.60m x 3.60m	£690.00
4.20m x 4.20m	£780.00
4.80m x 4.80m	£840.00
RECTANGULAR	
3.00m x 2.40m	£540.00
3.60m x 2.40m	£600.00
3.60m x 3.00m	£660.00
4.20m x 3.00m	£720.00
4.20m x 3.60m	£750.00
4.80m x 3.00m	£750.00
4.80m x 3.60m	£780.00



From
£498.00

Note: Supplied as a Flat Pack.



PICNIC TABLE

SPECIFICATION	COST
1.83m Wide	£242.13



Note: Supplied as a Flat Pack.

ROUND PICNIC TABLE

SPECIFICATION - 2.13M (OVERALL DIA.)	COST
Without Seat Backs	£381.10
With Seat Backs	£492.40



Note: Supplied as a Flat Pack.

BENCH SEAT

SPECIFICATION	COST
1.22m Wide	£399.553
1.52m Wide	£424.68
1.83m Wide	£495.25



TWIN SEAT WITH TABLE

SPECIFICATION	COST
Straight	£476.18
Angled	£476.18



Manufactured on site from high quality Scandinavian Redwood, once made they are pressure treated to ensure a long lifespan.

WOODEN OBELISK

SPECIFICATION	COST
1.22m high	£88.64
1.52m high	£93.93
1.83m high	£99.23
2.1m high	£104.52

Our handcrafted Wooden Obelisks are suitable for a wide range of climbing plants and are the perfect addition to your garden.



BENCH & TABLE SET

SPECIFICATION	COST
1.5m Long	£332.07



From
£332.07

Note: Supplied as a Flat Pack.



COROLINE NAILS

SPECIFICATION	COST
Matching Colour	£0.16



COROLINE SHEETS

SPECIFICATION	COLOUR	COST
900mm x 2000mm	BLACK	£28.34
900mm x 2000mm	GREEN	£29.85
900mm x 2000mm	BROWN	£29.85
900mm x 2000mm	RED	£29.85



From
£28.34

COROLINE RIDGE SHEETS

SPECIFICATION	COLOUR	COST
900mm	BLACK	£16.38
900mm	GREEN	£16.38
900mm	BROWN	£16.38
900mm	RED	£16.38



From
£16.38

ROOFING FELT

SPECIFICATION	COST
10m x 20kg Roll Green Mineral Felt	£42.16
10m x 38kg Roll Green Mineral Felt	£76.43
10m x 20kg Roll Black Polyester Felt	£52.91
10m x 20kg Roll Green Polyester Felt	£52.91
5L Felt Adhesive	£27.59

PLYWOOD

SPECIFICATION	COST
2.44m x 1200mm x 9mm Hardwood Exterior	£30.12
2.44m x 1200mm x 12mm Hardwood Exterior	£35.46
2.44m x 1200mm x 18mm Hardwood Exterior	£39.60
2.44m x 1200mm x 12mm Marine	£69.00

OSB BOARD

SPECIFICATION	COST
2440mm x 1220mm x 11mm	£19.10
2440mm x 1220mm x 18mm	£27.84



From
£19.10



From
£30.12



INSULATORS

SPECIFICATION	COST
Egg Insulator Pack of 5	£9.13
Saddle Insulator Pack of 50	£17.96
Nail on Insulator Pack of 50	£18.38
Red Bobbin Insulators Pack of 20	£8.28
100x Red Bobbin Insulators	£38.15
Screw in Insulator Pack of 20	£16.61
Screw in Insulator Pack of 100	£65.14
Claw/Snug Nail on Insulator Pack of 20	£16.87
Claw/Snug Nail on Insulators Pack of 80	£48.55
Nail on Tape Insulator Pack of 20	£20.93



GATES

SPECIFICATION	COST
Spring Gate up to 5m	£22.37
Electro-Tape Gate	£26.22
Bungee Gate	£36.04
Gate Handle	£5.23
Tape Gate Handle	£9.03

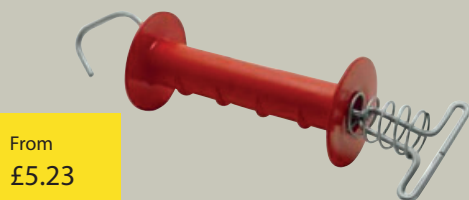

From
£5.23

WIRE

SPECIFICATION	COST
Galvanised Wire 200m 7x0.50	£44.56
Galvanised Wire 400m 7x0.50	£87.05
250m x 6 Strand Polywire	£29.52
500m x 6 Strand Polywire	£57.16
Lead Out Cable 25m 1.6mm Galvanised Core	£30.59
Lead Out Cable 50m 1.6mm Galvanised Core	£60.22



From
£30.59

TAPE/ROPE

SPECIFICATION	COST
200m Paddock Tape 20mm	£35.92
200m Paddock Tape 40mm	£64.49
200m Turbo Charge Rope	£58.85



ACCESSORIES

SPECIFICATION	COST
10KV Tester	£34.58



CONVERSION CHART



FEET	METRES
1	0.304
2	0.609
3	0.914
4	1.219
5	1.524
6	1.828
7	2.133
8	2.438
9	2.743
10	3.048
11	3.352
12	3.657
13	3.962
14	4.267
15	4.572
16	4.876
17	5.181
18	5.486
19	5.791
20	6.096

INCHES	MILLIMETRES
1	25.4
2	50.8
3	76.2
4	101.6
5	127.0
6	152.4
7	177.8
8	203.2
9	228.6
10	254.0
11	279.4
12	304.8

A Unique Piece

As wood is a natural product, it is liable to react to fluctuations in humidity and temperature, which can result in cracks and splits. Every piece is individual and will have unique features such as knots. These are all natural characteristics of wood and are to be expected, though this will not affect the strength and durability.

STOCKBRIDGE WOOD
HINTON ST GEORGE
SOMERSET TA17 8TN

OPENING TIMES

Monday - Friday: 8.00-5.00

Saturday: 8.00-12.00

Call: +44 1460 76238
Email: info@yarcombewp.com
Web: www.yarcombewp.com



Follow us
[yarcombewp](#)



Find us
[yarcombewoodland](#)

Scan for our
Showroom 3D
Virtual Tour



Scan for our
Workshop
3D Virtual Tour

